

4. EXPERIMENTAL FACILITIES IN BEAM HALL

4.1 GENERAL PURPOSE SCATTERING CHAMBER (GPSC)

Golda K. S, A. Kothari, P. Barua, P. Sugathan, S.K. Datta, and R.K. Bhowmik.

The GPSC facility is being used for both Nuclear Physics as well as Material Science experiments. Most of the works carried out this year include development and maintenance, that are related to the experiments carried out in this beam line. New detectors and mounts have been developed. The high vacuum pumping system has been upgraded, and the signal propagation from GPSC to Data acquisition station has been tested for proper connection and termination.

4.1.1 New Developments in the chamber

Golda K.S., Ashok Kothari, P. Barua, S.K. Saini and Sunder Rao

- (a) Aluminium spacers are fabricated to mount and fix different sized partially and fully depleted Silicon PIPS detectors inside the chamber.
- (b) Components needed for Glycol based cooling system for six surface barrier detectors are fabricated and leak tested.
- (c) A 5' long beam dump with a movable stand is made for experiments with neutron detectors. Faraday cup read out connection is available at the end of the beam dump. Wax blocks of necessary shape and dimensions are made for proper neutron shielding of beam dump so that neutron detectors used at the forward angles do not see neutrons from the beam dump.
- (d) Stands for neutron detector array are modified so that the detectors can be kept in the horizontal position at a distance of 1m from the target.
- (e) Remote controlled auto slit is installed at the chamber entrance for controlling the beam size for material science experiments.

4.1.2 Development of large area MWPC for fission fragment detection

Golda K.S., S. Saha¹, Ashok Kothari, P. Barua, P. Sugathan, T. Varughese, S.K. Datta, and R.K Bhowmik

¹Saha Institute of Nuclear Physics, Kolkata

GPSC Nuclear Physics experiments normally include heavy ion fission reactions and the study of different properties of fission fragments such as mass, energy and angular distributions. To facilitate this kind of experiment a large area MWPC is developed. This is a 5 cm × 15 cm active area detector which gives X-position, Energy and Timing information of the particle which pass through it. Position information is derived from

delay line read out at the ends of X-wire plane. Gold plated Tungsten wires soldered on

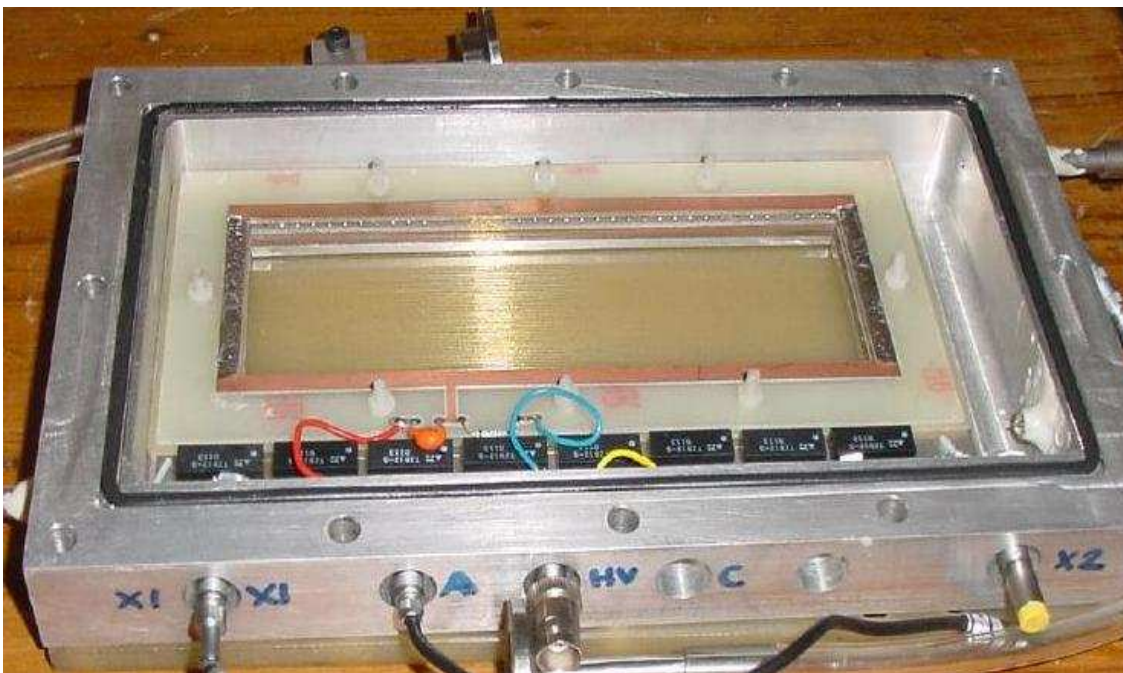

1.6 mm thick PCB are used as electrodes. Sense wires are placed at 2 mm separation and the delay between consecutive wires is 2 ns. Separation between two electrodes is 3.2 mm. The electrode configuration used for this detector is Cathode-X-Anode along the direction of particle. Timing signal is extracted from the anode and energy from the cathode. Voltage is applied through anode and cathode connections and the X-plane is kept at ground. The detector is tested with ^{252}Cf fission source at 3-5 torr at a reduced voltage of $\sim 350\text{V/cm/torr}$ and found to have position resolution of about 1.5 mm.

Fig. 1: Large Area MWPC

4.1.3 Development of detectors and related accessories for fast timing measurements

Golda K.S., P. Sugathan, S.A. Khan, S.K. Saini and S.K. Datta

For medium and heavy nuclei, time of flight measurement is one of the methods that can be used to separate out residues from elastically scattered particles since the velocity of evaporation residues is much different from that of elastically scattered particles. Small area PPAC is an excellent instrument for this kind of setup. Two PPACs and two PGACs have been made for this purpose and tested out with fission fragments of ^{252}Cf fission source in a TOF set up. Timing resolution is found to be 600 ps with out applying any correction. The detector performance testing was tried with ^{16}O beam on Au target to separate the residues from elastics but due to the high noise pick up from the chamber we were not able to extract proper timing signal from the detector. An indigenously de-

veloped fast preamplifier is tested with this set up and found that its timing performance is as good as commercially available ones.

4.1.4 Measurement of Neutron detector efficiency

Golda K.S., R.P. Singh, S.K. Datta and R.K Bhowmik

Till now for the efficiency determination of the neutron detectors we depend on the available monte carlo code; MODEFF. But since these calculations do not match with the actual values in all experimental conditions one should go for an experimental measurement. As a primary attempt, an experiment is done to measure the relative detection efficiency of 5" dia \times 5" thick BC501 liquid scintillation neutron detector by measuring energy spectra of prompt neutrons from a ^{252}Cf spontaneous fission neutron source using time of flight technique. A 2" dia \times 1" thick plastic scintillator is used as the start detector for the associated γ -ray emitted from the fission fragments. Data is collected for a period of about two months. The event by event mode data collected consists of TOF, dynode pulse height and PSD for neutron-gamma discrimination. The electron energy calibration of the pulse height is carried out by measuring maximum Compton recoil energies of different gamma-ray sources. The obtained TOF spectra are converted into energy spectra with proper application of Jacobian conversion. The rest of the analysis is going on.

^{252}Cf neutron spectrum

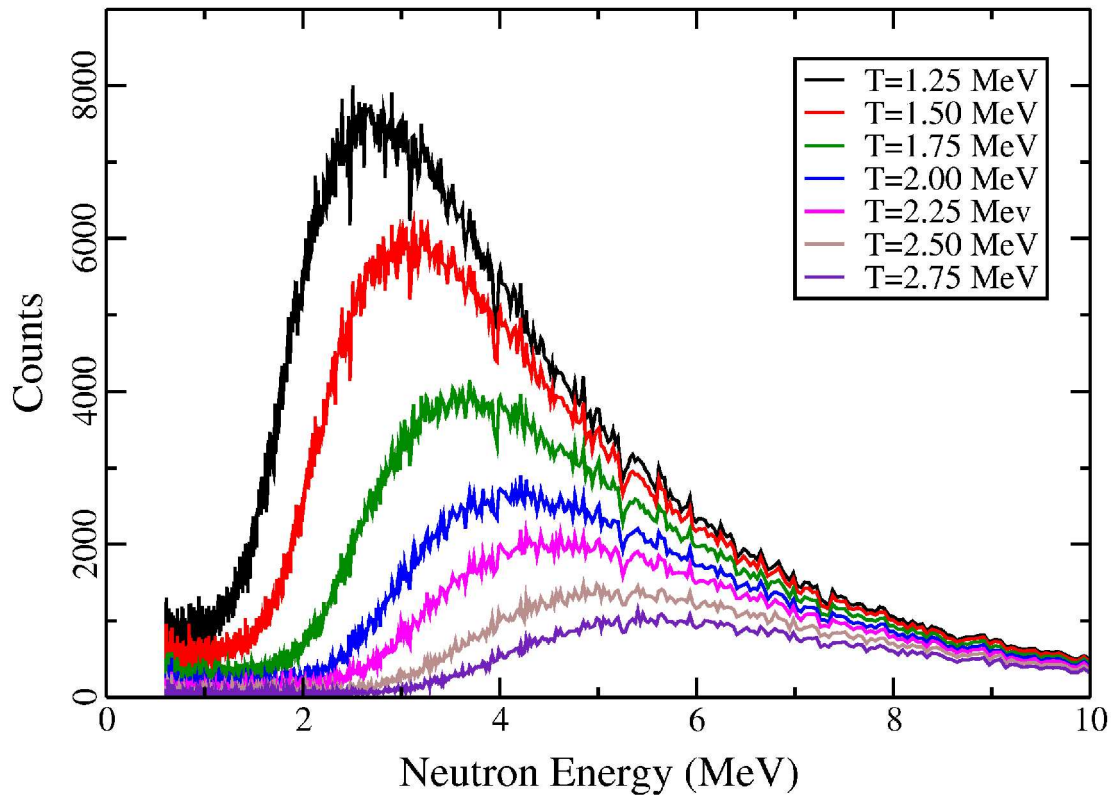

Fig. 1: Measured neutron energy distribution of ^{252}Cf at different threshold settings

4.1.5 PSD module for neutron-gamma discrimination

Rakesh Kumar, Golda K.S., S. Venkataramanan, S.K. Datta and R.K. Bhowmik

This is a single width NIM module for neutron-gamma Pulse Shape Discrimination. Four modules of dual channel PSDs are fabricated indigenously. Each channel consists of two parts; one CFD and one PSD; this special characteristic makes it self sufficient to be used in TOF set ups without the incorporation of any other modules. This compact module is as good as the commercially available ones in their performance. The modules are tested satisfactorily for their performance and stability with ^{252}Cf source. FOM of the module is comparable with commercially available CANBERRA made module. The modules are also tested with Lithium beam on Al as well as Mylar target and is used in an experiment successfully.

Time vs Energy spectrum showing different bumps for neutron and gamma obtained from NSC made module and CANBERRA module.

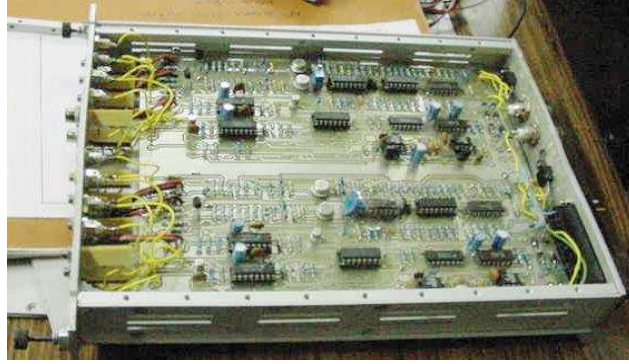

Fig. 1: Dual Channel PSD module

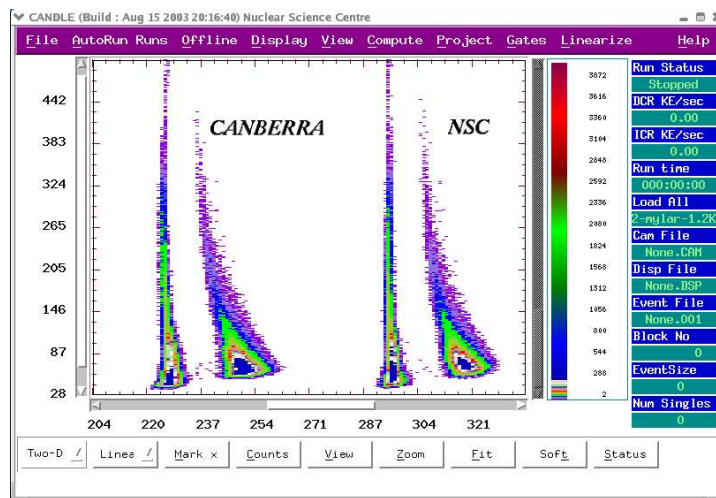

Fig. 2: Pulse Shape Discrimination using NSC and CANBERRA modules

4.1.6 Experiments Conducted in GPSC

There were many Nuclear Physics as well as material science experiments conducted in GPSC last year. The list of experiments are given below:

Nuclear Physics Experiments

Sl.No	PI & University/ Institution	Title of Experiment
1	Avinash Agarwal, AMUniversity	Study of complete and incomplete fusion reactions using heavy ions
2	Tilak Kr. Ghosh, SINP, Kolkata	Study of heavy ion induced fission fragment angular and mass distr. at near/sub-coul barrier energies.

3	Ajay Tyagi, Punjab Univ.	Study of dynamical and entrance channel effect in fusion reaction via neutrons
4	B.P. Singh, AM University. Aligarh	To study complete and incomplete fusion and pre equilibrium emission in Nuclear reactions induced by heavy ions.
5	M. Afzal Ansari, AMU, Aligarh	Study of incomplete fusion reactions induced by heavy ions.

Material Science Experiments

Sl. No.	PI & University/ Institution	Title of Experiment
1	Ranimol Stephen, MGU, Kottayam	Study on the effect of ionbeam irradiation on natural/synthetic rubber lattices and their blends.
2	H. S. Nagaraja, NSC	Sputter yield measurement in organic systems
3	Walter Assman, LMU' GERMANY	Ion Beam mixing
4	Naveen Acharya, Univ. of Rajasthan	Development and characterization of polymeric membrane filters
5	B. Sannaki , Gulbarga University P.K. Diwan, Kurukshetra Univ.	Energy loss of heavy ions in polymers / SHI in polymers : Some fundamental aspects
6	Arun Batra, ISRO	Heavy ion induced effects in VLSI devices.

4.2 Gamma Detector Array (GDA)

Kusum Rani, Rakesh Kumar, S. Muralithar, R.P. Singh, and R.K. Bhowmik

The activity in the GDA laboratory in this year was devoted in the following areas:

- 3 Testing of NSC Clover electronics module
- 4 Large Gamma detector Array

4.1.5 Large Gamma Detector Array (LGA)

K.S. Golda, Rakesh Kumar, R.P. Singh, S. Muralithar, S. Nath, J.J. Das, N. Madhavan, P. Sugathan, A. Jhinghan, T. Varughese, Kusum Rani and R.K. Bhowmik

With the success of bringing together a small array of Clover detectors at TIFR and NSC during 2001-2003, we are gradually approaching the overall objective of assembling a large Clover array with up to twenty-four Clover detectors for high-sensitivity γ -spectroscopy measurements. A joint proposal for setting up an Indian National Gamma Array (INGA) in collaboration with other research institutions, i.e. TIFR, BARC, VECC, SINP and IUCDAEF-Kolkata, has now been finalised and submitted to DST for funding. In parallel, planning of the detector arrangements to be used in conjunction with the Recoil Separator HYRA in the new Beam hall of NSC has been initiated.

At NSC, it would be necessary to use the Clover array either on its own or in coincidence with HYRA. As a result, the front eight detectors have to be removable and the sixteen detectors in the backward hemisphere have to be moved over a distance ~ 2 m for optimised solid angle coverage. The mechanical structure holding the clover detectors has been redesigned for better clearance between neighbouring ACS shields. The structure holding the detectors in backward hemisphere would be mounted on a movable platform on precision rails for allowing the structure to be shifted from one location to another without the need to dismantle the Clover detectors. The forward detectors would be mounted on two independent rails so that they can be moved out of way for INGA at the HYRA target location.

The layout of the INGA structure in the new beam hall of NSC has been finalised. The mechanical design of the support structure and the platforms is in progress. Fabrication of a liquid nitrogen filling system for controlling up to thirty-two detectors has been completed. The controller has an on-board computer allowing communication through an ethernet port.

Significant progress has been made in the fabrication of analogue processing electronics, ADCs and the data acquisition system capable of handling the vastly increased data rate from the INGA array.

4.2.2 Fabrication and Testing of NSC Clover electronics module

S. Venkatramanan, Rakesh Kumar, E.T. Subramanium, Mamta Jain and R.K. Bhowmik

A compact electronics module for the processing of the energy and timing signals from the four segments of a Clover detector was reported last year (NSC Annual Report 2002-2003). Twelve such modules have now been fabricated which have undergone thorough testing using a gamma source. The linear amplifier sections have three jumper-selectable gain settings of 2, 4 and 6 MeV full scale (10 Volt). For use with a segmented LEPS detector, one of the settings can be modified for a full scale range of 0.5 MeV. The measured noise for all four gain settings was less than 500 μ v rms with respect to the output. Fig 1 shows the energy spectrum for ^{152}Eu source for three different gain settings.

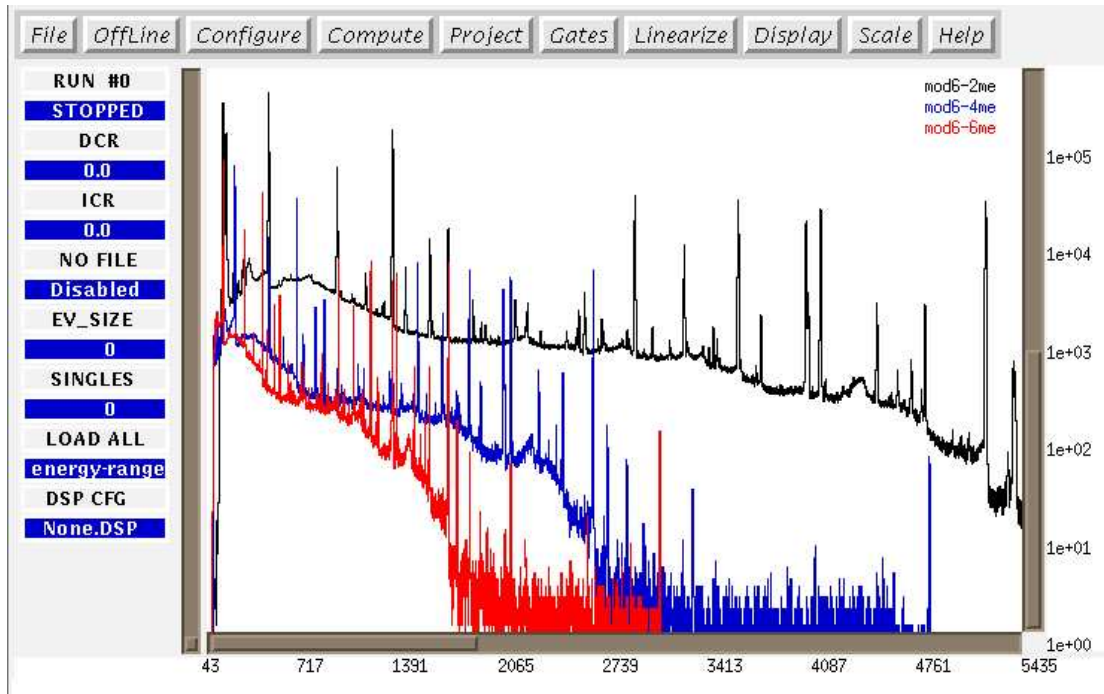

Fig. 1 Energy Spectrum from ^{152}Eu source for gain settings of 2,4 & 6 MeV Full scale

We have carried out a systematic study of the linearity and stability of these locally fabricated modules. The integral linearity over the full output voltage range was measured to be better than 1 part in 10^4 . Fig 2 shows the measured peak shift for the 1408 keV peak as a function of time for three modules. The measured gain drift was less than 1 part in 10^4 over a period of 24 hours.

Fig 2 : Gain Drift measurements using NSC-made Clover Electronics ((each data point corresponds to spectra accumulated over a period of ~ 90 min.)

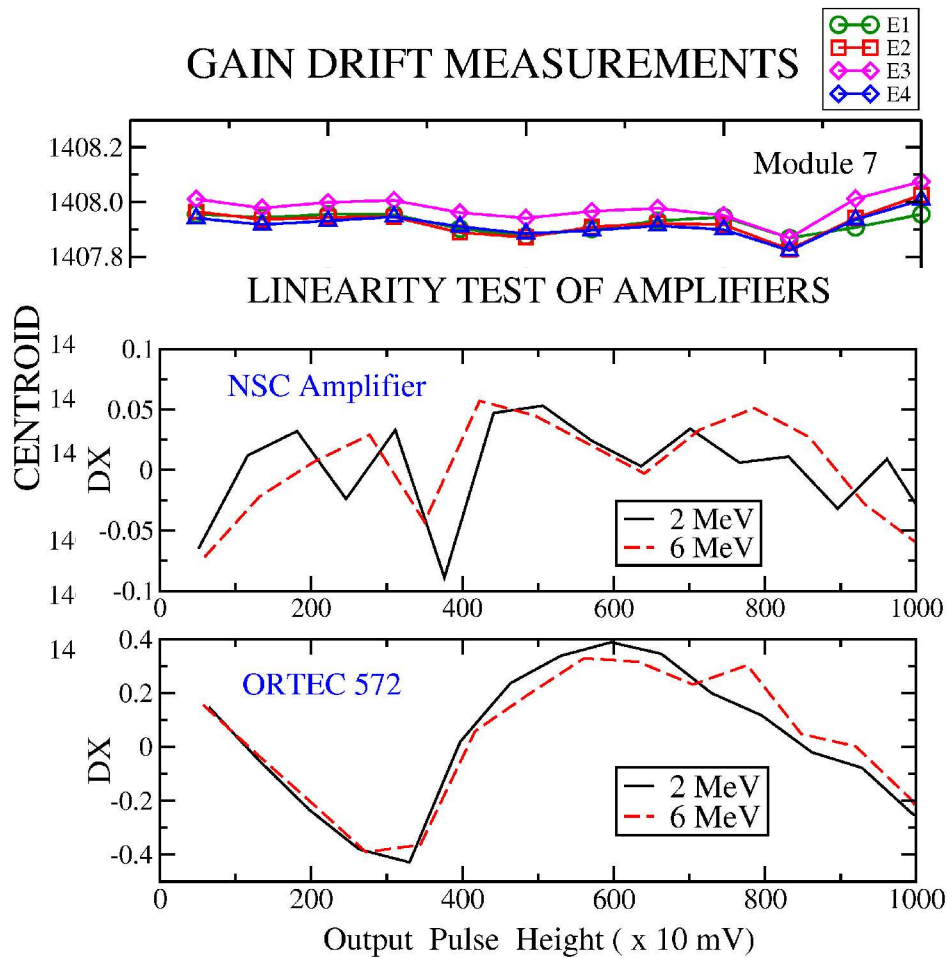

Fig. 3: Test of integral linearity of Ortec 572 and NSC – designed Clover amplifier

4.1.6 HIRA-INGA System

K.S. Golda, Rakesh Kumar, S. Nath, R.P. Singh, N. Madhavan, J.J. Das, A. Jhingan, P. Sugathan, S. Muralithar, Kusum Rani, S. K. Saini, B.P. Ajith Kumar, S. Venkataramanan, T. Varughese, A.J. Malyadri, V.V.V. Satyanarayana, V. Patel, P.V. Madhusoodhana Rao, E.T. Subramanian, R. Ahuja, A. Gupta, S. Rao and R.K. Bhowmik

BHU, DU, PU, BU, AU, CU, VBU, GU, GNDU, IITR, TIFR, SINP, IUC-DAEFC-CC, VECC

The combined experimental facility of INGA in its present form, with Heavy Ion Reaction Analyser (HIRA) was set up in November 2002. Experiments using this facility were continued up to May 2003 with a total of sixteen experiments completed during this period. Preparation work for installing the array at VECC in early 2004 has been started.

All the Clover detectors have been removed from the mechanical stand, and most of the data racks and cabling have also been removed from the LIBR area to make room for the AMS facility.

The following experiments were conducted using the INGA+HIRA system during the period April 2003 - May 2003:

Description	Beam	Energy (MeV)	User	Facility
γ ray spectroscopy in the region A ~ 52	^{28}Si	70	IMG/PU	HIRA+Clover Ge
Search for shape effects in ^{78}Rb	^{19}F	60	LC/BHU	Clover Ge
Nuclear Structure ^{139}Pr	^{28}Si , ^{14}N	140, 75	SKB/VECC, SC/FCC	Clover Ge
High Spin study In A~ 65	^{19}F	65	B.V.T.Rao AU	Clover Ge
Nuclear structure study of odd-odd $^{124,126}\text{Cs}$, ^{122}I	^{28}Si	130	NS/PU	Clover Ge
Spectroscopy of n-rich nuclei	^{34}S	140	AKS/IUC-DAEF, CC	Clover Ge, HIRA
High spin Isomer study	^{31}P	120	SSG/IUC-DAEF, CC	Clover, HIRA

4.3 RECOIL MASS SPECTROMETERS

4.3.1 Heavy Ion Reaction Analyzer (HIRA)

Subir Nath, Akhil Jhingan, Thomas Varughese, J. J. Das, P. Sugathan, N. Madhavan, P. V. Madhusudhana Rao¹, S. Barua², K. Kalita³ and S. Verma³

¹Department of Physics, Andhra University, Visakhapattinam

²Department of Physics, Gauhati University, Guwahati

³Department of Physics, Delhi University, New Delhi

During the past year, HIRA was used in 7 experiments, four in conjunction with INGA setup and three using ^7Be RIB.

In the period April to May 2003, the remaining experiments with HIRA-INGA combination were taken up. These include Nuclear Structure in $A \sim 130$ amu (Panjab University), Spectroscopy of nuclei in $60 < A < 70$ amu (Andhra University), Spectroscopy of n-rich nuclei in $30 < A < 40$ amu using transfer reaction (IUC-DAEF, Kolkata) and Search for high spin isomers in $A \sim 90$ amu region (IUC-DAEF, Kolkata). For the isomer experiment, the nuclei of interest were transported through HIRA to the focal plane, mass selected and the delayed gamma transitions were detected using a

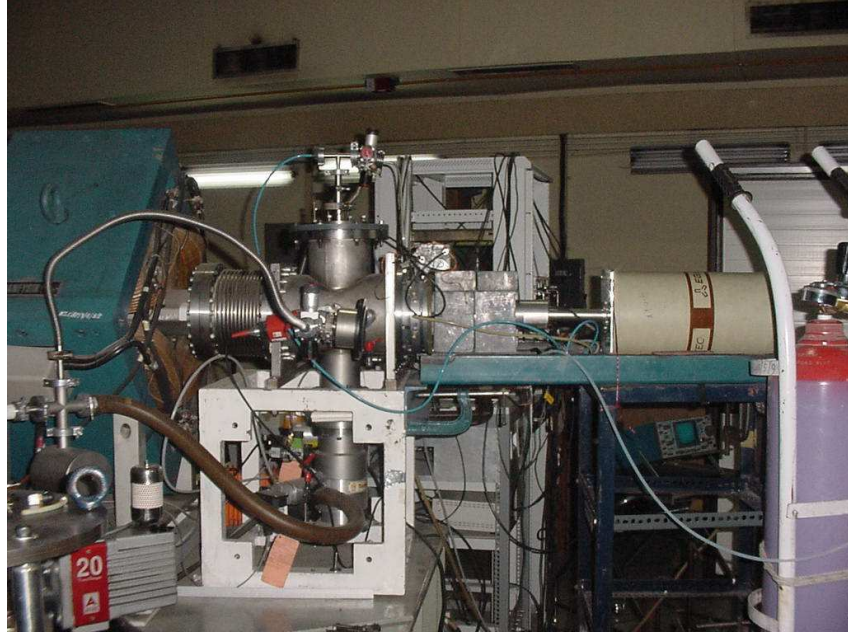

Fig. 1 : HIRA focal plane setup for microsecond isomer study

HPGe detector. This helped in matching the prompt gamma transitions above the isomeric state detected with clover detectors at the target site and the delayed gamma transitions below the isomeric state with HPGe detector at the focal plane of HIRA. The focal plane was suitably modified (Fig. 1) with the SS blank-off beyond the MWPC replaced by a perspex flange to reduce the gamma attenuation. The nuclei of interest were stopped in the perspex flange and the delayed gamma rays were detected with a 23% relative efficiency HPGe detector. Suitable shielding around the detector helped in suppressing the background and chance coincidences. The electronics was suitably modified to get the lifetime of the isomeric states and the correlation between prompt and delayed transitions (details given elsewhere in this report).

The new focal plane chamber (Fig. 2) was installed and aligned with respect to the exit direction of HIRA in June 2003 after the completion of HIRA-INGA experiments. The large bellow beyond the last quadrupole chamber was replaced by a shorter one of same diameter to have the focal plane detector closer. The small, aluminium target chamber was replaced by the sliding seal chamber and the rotary/linear motion target foil system was re-installed for the experiments using ^7Be RIB.



Fig. 2 : New chamber installed at the focal plane of HIRA

The focal plane setup was modified and the large area telescope detector (mentioned in 4.3.2 of NSC Annual Report 2002-03) was installed. To prevent the bulging exit foil of the ionization detector from touching the 2D detectors, a modification was carried out in the detector system and two separate exit foils of smaller dimensions were used instead, in front of the two 2D detectors. Four CsI detectors from BARC were mounted at back angles to detect the light charged particles (protons and alpha particles) evaporated from the compound nucleus to estimate the fusion cross-section in addition to the elastic and transfer measurements with the forward, large area telescope detector. The sensitivity of the CsI to X-rays emitted from ED2 electrodes during momentary voltage instabilities was circumvented by shielding the back of the CsI detectors. This setup was used in the ${}^7\text{Be} + {}^{27}\text{Al}$ elastic/transfer and fusion reaction around barrier (Delhi University + BARC + SINP + NSC, July 2003) and is shown in Fig. 3. The same setup except for the CsI detectors was used again in elastic scattering measurements in ${}^7\text{Be} + {}^9\text{Be}$ system (Delhi University + BARC + NSC, February 2004).

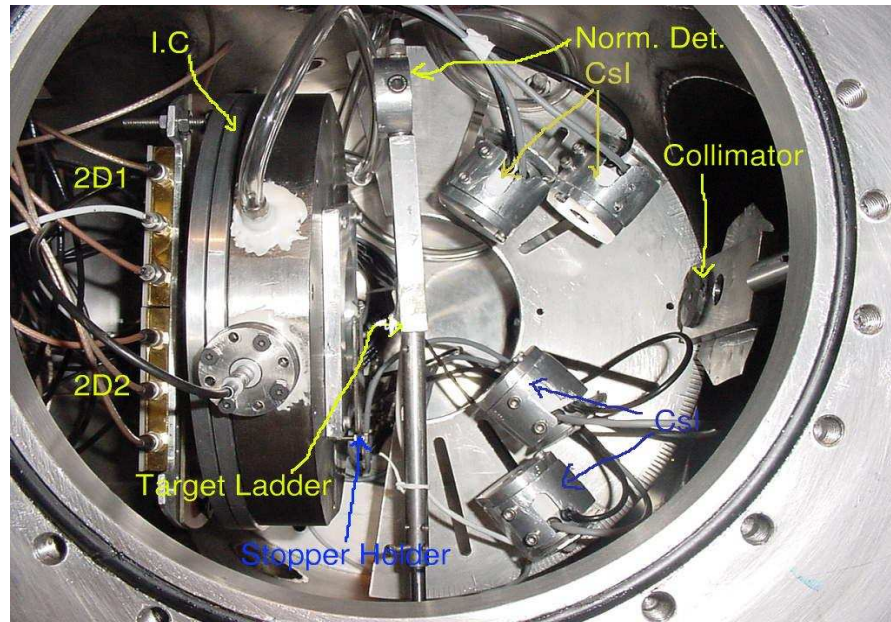

Fig. 3 : Large area telescope detector (for elastic/transfer) and CsI detectors (for light charged particles from fusion) at focal plane of HIRA

An earlier ^7Be implantation experiment in various host elements such as Fullerene, Gold, etc., (VECC, Kolkata) to look for small deviations in the decay rate of ^7Be in various electronic environments, was found to require experimental differentiation between the ^7Be ions implanted in the interstitial positions and those inside the Fullerene molecules to conclusively interpret the result. This was found to be possible by chemical treatment of irradiated samples of Fullerene. As the earlier irradiated samples are not useful any longer due to the short half-life (~ 52 days) of ^7Be , fresh implantation was carried out by implanting ^7Be ions in Fullerene as well as in Gold (for comparison) samples.

The transistor heat sinks of the magnet power supplies have shown signs of internal corrosion with several of them developing leaks in the past year. Spare heat sinks were used to replace the damaged ones and in some cases the leaks could be fixed by brazing. Simultaneously, several heat sinks have been made locally which will be used as future replacements.

4.3.2 Hybrid Recoil mass Analyzer (HYRA)

N. Madhavan, S. Nath, P. Sugathan, J. J. Das, A. Jhingan, T. Varughese, Rajesh Kumar, Rajkumar, B. Kumar, S. Suman, A. Mandal, R. Singh,¹ K. M. Varier,² M. C. Radhakrishna³ and A. K. Sinha⁴

¹Department of Physics and Astrophysics, University of Delhi, Delhi - 110 007

²Department of Physics, Calicut University, Calicut, Kerala - 673 635

³Department of Physics, Bangalore University, Bangalore - 560 056

⁴IUC-DAEF, Kolkata Centre, Bidhan Nagar, Kolkata - 700 092

The HYRA spectrometer, to be set up in the Phase II beam hall at NSC, is planned to be operated in both gas-filled mode and vacuum mode to access nuclei around and above $A \sim 200$ amu in normal kinematics and those up to $A \sim 100$ amu in inverse kinematics, respectively. The funding agency, namely, Department of Science and Technology (DST), Govt. of India has released seed money and the first installment. Most of the electromagnetic components, associated power supplies and vacuum systems required for the first part of HYRA (ie. the achromatic Q_1Q_2 -MD1- Q_3 -MD2- Q_4Q_5 - see Fig.1) which will also be used as gas-filled separator have been taken up. The electromagnetic components from MD1 to Q_5 and the power supplies for MD1, MD2 and Q_5 have been ordered and are expected to be ready for installation by the end of April 2005.

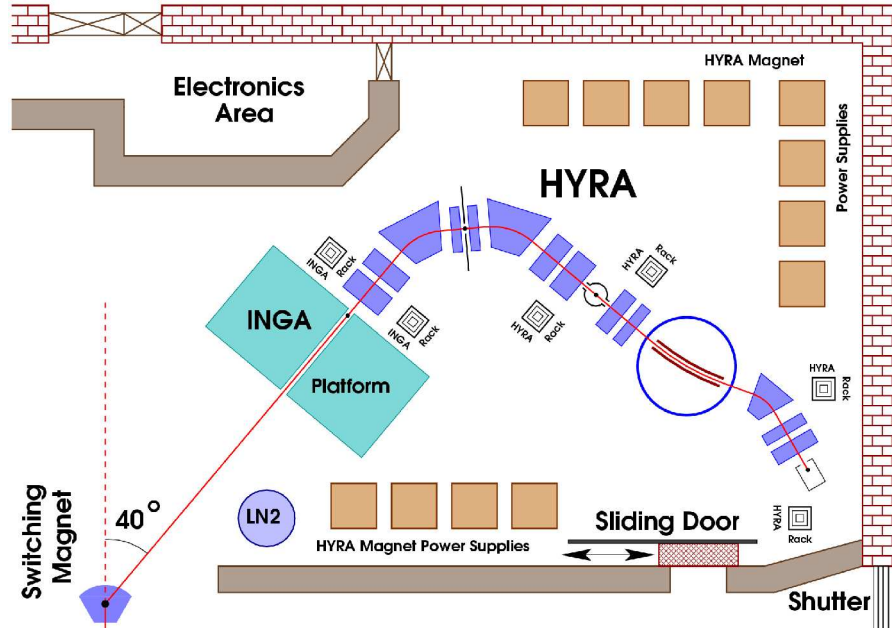

Fig 1 : Schematic layout of HYRA components in Phase II beam hall

The first quadrupole doublet can increase the acceptances in the two modes of operation significantly if superconducting, super-ferric option is used (see Table 1). This not only increases the pole-tip fields by a factor of three but also reduces their lengths to

Table 1 : Comparison of HYRA parameters with different options for initial drift [D_{Initial}] and first two quadrupole magnets [Q_1 & Q_2]

	Normal Q1 [l=0.6 m] & Q2 [l=0.5 m]			Superconducting Q1 [l=0.3 m] & Q2 [l=0.25 m]					
$D_{Initial}$	0.5 m			0.5 m			0.4 m		
Mode	GFS ¹	Achrom at ²	RMS ²	GFS ¹	Achrom at ²	RMS ²	GFS ¹	Achrom at ²	RMS ²
θ_{max}	± 125 mrad	± 30 mrad	± 25 mrad	± 165 mrad	± 45 mrad	± 37 mrad	± 195 mrad	± 48 mrad	± 39 mrad
ϕ_{max}	± 11 mrad	± 145 mrad	± 120 mrad	± 18 mrad	± 150 mrad	± 120 mrad	± 22 mrad	± 185 mrad	± 150 mrad
Ω_{max}	4.3 msr	13.7 msr	9.4 msr	9.3 msr	21.2 msr	14.0 msr	13.5 msr	27.9 msr	18.4 msr
B_{Q1}	+0.60 T	-0.64 T	-0.64 T	+1.78 T	-1.56 T	-1.56 T	+2.13 T	-1.78 T	-1.78 T
B_{Q2}	-0.11 T	+0.48 T	+0.48 T	-0.81 T	+1.28 T	+1.28 T	-1.01 T	+1.32 T	+1.32 T
M_x [Q3]		-0.5	-0.5		-0.8	-0.8		-0.8	-0.8
M_y [Q3]		-7.5	-7.5		-7.8	-7.8		-9.4	-9.4
D_p [Q3]		8 mm/%	8 mm/%		8 mm/%	8 mm/%		8 mm/%	8 mm/%
M_x [F1]	-1.2	1	1	-1.8	1.4	1.4	-2	1.5	1.5
M_y [F1]	-1	1	1	-1.4	1.1	1.1	-1.5	1.2	1.2
D_p [F1]	15 mm/%	0	0	15 mm/%	0	0	15 mm/%	0	0
M_x [F2]			-1			-1.5			-1.6
M_y [F2]			-1.7			-1.9			-2.1
D_M [F2]			10 mm/%			10 mm/%			10 mm/%

¹Calculations have been done taking particles with $B\rho = 2.16$ Tm.

²Calculations have been done taking particles with $B\rho = 1.42$ Tm.

half thereby focusing particles with large initial divergences into the dipole MD1 which is the main limitation for transport efficiency in the gas-filled mode of operation. The length of the gas medium also reduces and the higher fields help in reducing the distance between the target and the first quadrupole, which in turn increases the angular acceptances. Superconducting, super ferric quadrupoles of large apertures and shorter lengths have been made at NSCL, MSU (USA). Preliminary design calculations for the cryostat and the magnet are being carried out with the help of Cryogenics group at NSC adapting the MSU design to the requirements of HYRA quadrupoles.

Fabrication of Q_1 and Q_2 , their power supplies, target and first focal plane chamber, finger system and some more electromagnetic elements will be taken up with the second installment of funds. A high current, prototype power supply developed at NSC for HYRA quadrupole has been successfully tested with resistive, dummy load at 295 A and 85 V and found to have excellent stability. This in its final shape (suitably mounted in appropriate cabinet) will be used for Q_4 . Another similar power supply will be made to energise Q_3 .

The beam-line design is being done jointly with the INGA group at NSC (Dr. R. K. Bhowmik, S. Muralithar, R. P. Singh, Rakesh Kumar) to accommodate the INGA structure and to have possibilities for HYRA-INGA (16 clover detectors + 4 LEPS or neutron detectors), INGA-alone (24 clover detectors + 6 LEPS or neutron detectors) and HYRA-alone operations as per the experimental requirements.

4.4 MATERIALS SCIENCE FACILITY

A. Tripathi, Ravi Kumar, V.V. Shivakumar, F. Singh, S.A. Khan, T. Mohanty, Azher M. Siddiqui, D. Kabiraj, R.N. Dutt, P. Barua, A. Kothari, D. Kanjilal and D.K. Avasthi

The materials science facilities continue to be used by a large number of users from different universities and institutions from India and abroad. The swift heavy ion irradiation related experiments are performed in the three chambers in the beamline as well as in the general purpose scattering chamber. Besides this, the off-line facilities are also being used by many users for preparing and characterizing samples. A total of 49 user experiments comprising 155 shifts were performed in this year, without any beam time loss due to major facility break down. Special emphasis is being given to research programmes in thrust areas where group experiments are being conducted. Special attention is also given to research scholars' Ph.D. related experiments which comprised 22 experiments (61 shifts) this year. Experiments are being done in different areas of swift heavy ion induced materials modification and characterization and the details of the research programmes are given in Section 5.2.

The high vacuum chamber in materials science beamline is used in most of the experiments. This chamber was being pumped by a diffusion pump. This diffusion pump became in-operational this year due to a leak in the liquid nitrogen trap. Hence a 1000 l/s Turbo pump was installed and is being used for pumping the chamber. The ultra high vacuum chamber is pumped by a turbo pump and an ion pump. The turbo pump controller developed a snag this year which was rectified and the pump was made operational again. In the goniometer chamber a new software for the control and data acquisition through CAMAC has been developed and tested off-line. The test of the set up with the beam is to be done shortly. Efforts are on to make the *in-situ* X-ray reflectivity set up operational this year.

In the off line facilities, the polishing machine was repaired and made operational again. FTIR system Nexus 670 from Nicolet was acquired this year and has been installed. This system is put in use for vibrational structure analysis of materials.

4.4.1 Material Science Beamline for Phase II

A. Tripathi, P. Barua, A. Kothari, S.A. Khan, A.M. Siddiqui, A. Mandal and D.K. Avasthi

The installation of the beamline in the Beam hall II up to the irradiation chamber has been completed. The layout has been planned to incorporate in-situ FTIR facility in future. The *in-situ* XRD facility has been ordered and the system will be installed in this beamline. The complete layout of the materials science beamline has been finalised and its block diagram is shown in Fig. 1.

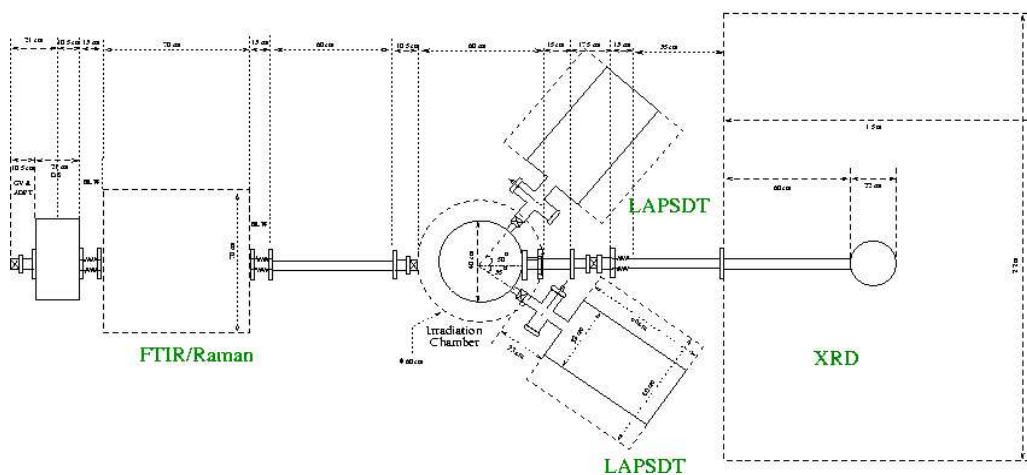

Fig. 1

4.4.2 Irradiation chamber for materials science beamline in beamhall II

A. Tripathi, R. Ahuja, S.A. Khan, M. Kumar¹, F. Singh and D.K. Avasthi

¹Department of Physics, University of Allahabad, Allahabad

The irradiation chamber for the materials science beamline has been installed in Beam Hall II. The irradiation chamber has 22 ports: 10 in the beam plane, 6 ports at a lower plane, 5 in the top lid and one in the bottom plate. The ports at two levels facilitate design of a longer target ladder with provision of mounting larger number of samples. This also makes it possible to reduce the diameter of the chamber resulting in larger solid

angle for detector. Two ports at 30° and 50° are provided for large acceptance angle for the detector for ERDA studies. The chamber has hand-lever screw arrangement for X, Y movement and bolt with bearing arrangement for smooth Z movements. Modified two way hydraulic lid lifting arrangement ensures smooth lid movement. Hydraulic lift has a load capacity of 120 kg load so that the sample ladder and linear and rotational arrangements can be mounted on the top lid. Figure 1 gives a view of the chamber.

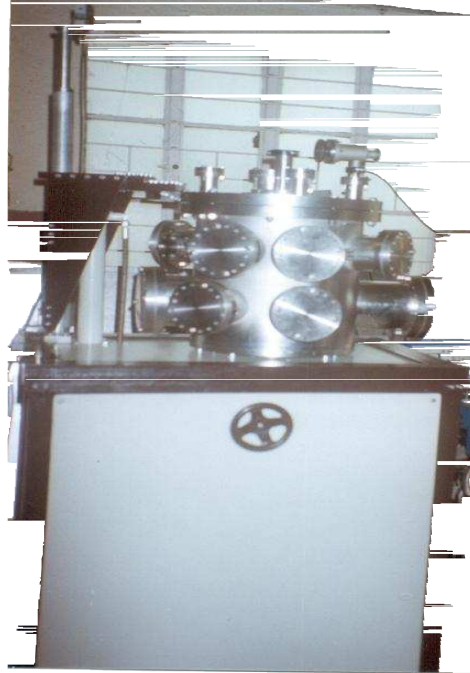

Fig. 1

The inspection of the chamber was done at Pune where its physical dimensions, angles of ports, straightness and ovality of flanges was checked. It was also tested for leaks with MSLD for a leak rate at better than 5×10^{-9} torr-l/s.

However during installation the chamber developed a leak in one of the ports in the top lid after baking. This leak was rectified at NSC to save time and the chamber was tested up to a vacuum of 10^{-8} torr.

The target ladder, detector mount and the feed through flange have also been fabricated and installed. The designs for liquid nitrogen cooled ladder, sample linear and rotational motion and secondary electron suppressor have been finalized and are being fabricated. Plans for fabrication of beam scanner, feed through flange, vacuum system controller and sample ladder movement controller are underway.

4.4.3 Swift Heavy Ions in Materials Engineering and Characterization (SHIMEC)

D.K. Avasthi, A. Tripathi, Ravi Kumar, F. Singh, S.A. Khan, V.V. Shivakumar and D. Kanjilal

The SHIMEC programme has been funded by DST under its Intensifying Research in High Priority Areas (IRPHA) programme. The thrust areas identified under the project are the study of Phase transformation, Electronic/ Potential Sputtering, Surface/Interface modification, Ion beam induced epitaxial crystallization, Nano phase modification and synthesis and Transient-enhanced diffusion.

The following instruments are being acquired under the project:

4.4.3.1 Atomic Force Microscope/ Magnetic Force Microscope

A. Tripathi, S.A. Khan, Ravi Kumar, F. Singh and D.K. Avasthi

Multi Mode SPM with Nanoscope IIIa controller has been acquired from Digital Instruments Inc. The system has the following options/attachments: Contact/ Non-contact/ Tapping Atomic force microscopy, Scanning tunneling microscopy (STM), Magnetic force microscopy (MFM), Lateral force microscopy (LFM), Electrical force microscopy (EFM) and conducting AFM options.

The system will be used for the following areas of study: Ion induced surface morphology, SHI induced changes in size and its distribution of nanoparticles, SHI induced modification in magnetic domains, SHI induced plastic flow of material and Characterization of ion tracks in terms of size and number density.

The system has been installed and is operational. The AFM /STM/MFM system is

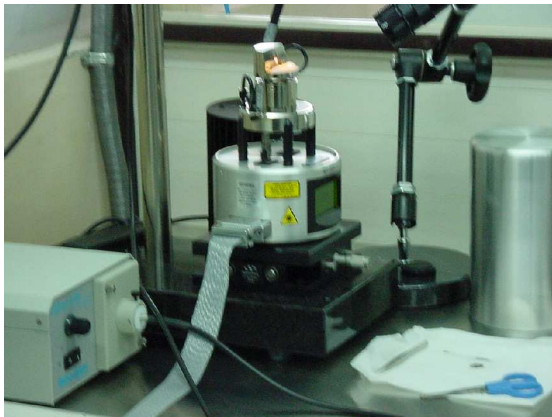

shown in Fig.1. Surface topograph of HOPG surface taken by STM is also shown in Fig.2
Fig. 1

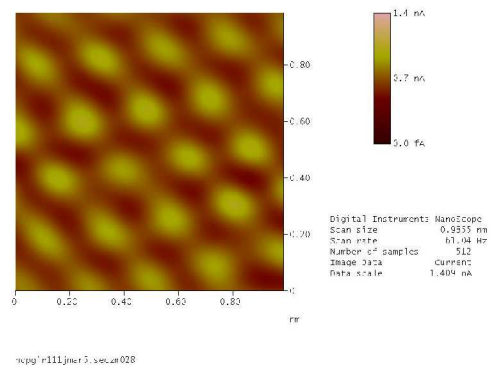

Fig. 2

4.4.3.2 *in-situ* XRD set ups

F. Singh, A. Kothari, R. Ahuja, A. Tripathi, Ravi Kumar and D.K. Avasthi

In-situ XRD has been ordered from Bruker AXS Germany (Model D8 Advance). The system consists of a 3 kW X-rays source with multi-layer mirror and will have the thin film attachment. The system will have position sensitive Vantage detector for up to 100 times faster data acquisition for bulk systems or films of thickness more than 10 μm .

This system will be installed in the beamhall and will be used for studies in the following areas: Novel phase formation, Phase transformations, SHI induced changes in size of nano particles and Surface and interface modification using XRR mode.

The chamber for the abovementioned system is being designed and its tentative drawing is shown in Figure 1.

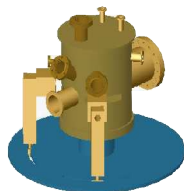

Fig. 1

4.4.3.3 On-line QMA/RGA system

A. Tripathi, S.A. Khan, F. Singh, Ravi Kumar and D.K. Avasthi

The Pfeiffer QMA 422 quadrupole mass analyzer system with SIMS option for mass range 1-1024 amu is also being acquired under IRHPA project. The quadrupole mass analyzer will have a 3 lens optics for detecting both positive and negative ions as well as neutral atoms. Some of the proposed areas of research are: On line detection of release of gases, specially from polymer and online study of electronic sputtering. The schematic of the system is shown in Figure 2.

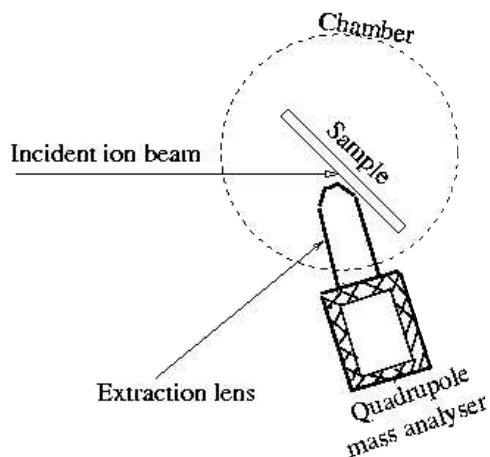

Fig. 2

4.4.4 Plasma based thin film deposition

V.V. Siva Kumar

The RF sputtering system was operational for tests and thin film deposition. Problems related to vacuum leaks from O-rings due to high annealing temperatures maintained during deposition are solved. The system was used to test an RF amplifier and LC matching network developed by M/S VEQCO, Delhi, for thin film deposition from 2" diameter and 4" diameter targets. An operation manual is prepared for the system to help the users with thin film deposition by setting the required deposition parameters. Thin films of Copper nitride, ferrite and nc-Si/SiO₂ were grown by users. A circuit is made and incorporated in the LC matching network to measure the negative self bias on the cathode. It will be calibrated.

The RF Ar-O₂-Cu discharge used for nano-phase copper oxide thin film deposition was studied in detail using optical emission spectroscopy. The relative intensities of copper and oxygen species are correlated to the phase formed in the thin films.

An ECR plasma based thin film deposition system has been designed. The components for the vacuum system, gas flow system and pressure control system are procured. The chamber has been designed and fabricated with provisions to deposit thin films by CVD and sputtering. The microwave/ECR components needed to produce the ECR plasma are identified and are being procured. Assembling and testing of the system for thin film deposition will be undertaken next year.

4.4.5 LAPSDT with new design features

S. A. Khan, M. Kumar¹, D. K. Avasthi, A. Jhingan, A. Tripathi and A. C. Pandey¹

¹Physics Department, University of Allahabad, Allahabad-211 002

A new Large Area Position Sensitive Detector (LAPSDT) has been fabricated to be used in beam hall I. Already existing LAPSDT will be used in phase II where it is more suitable because of its larger and deeper active region. In this report we describe the new LAPSDT and present its off-line test results.

The electrode structure of detector consists of anode, cathode and grids. The anode has three sections, $\Delta E1$, $\Delta E2$ and $\Delta E3$ of 40, 80 and 160 mm length respectively. The cathode is mounted at a distance about 110 mm from anode and frisch grid is at 20 mm from anode. The detector features a grid electrode for total energy measurement which is located 10 mm above the frisch grid and 10 mm below the anode. All these electrodes form an active area which is 280 mm long and 90 mm wide. The length of the detector is sufficient to stop the recoils from carbon and above elements at nominal gas pressure.

The $\Delta E2$ has been converted into backgammon structure to derive directly the horizontal, in plane, coordinate (x) of each event. The knowledge of this coordinate will be useful in correcting the kinematic broadening of the detector which is possible due to large solid angle of 5 msr. The y -coordinate is obtained from the ratio of cathode signal to the sum of $\Delta E1$, $\Delta E2$ and $\Delta E3$ signals.

The window assembly, 60 mm in diameter, is positioned centrally between frisch grid and cathode and 3 mm apart from the edges of the electrodes. Six micron polypropylene is stretched on the teflon window and supported by 70 μm wires. There is a provision for biasing entrance window as well. For the field homogenization in sensitive volume, voltage-graded guard wires are used on both the sides.

The electrodes form a rigid structure with the usage of perspex support blocks and nylon screws. The entire detector has been mounted on a movable stand which also hosts a NIM power crate with its dedicated electronics. Two commercial pre-amplifiers have been used in addition to four available home-made preamplifiers.

To detect lighter elements (H, Li, etc.) which cannot be stopped inside the sensitive length, the detector chamber also houses a large area SSBD (MS X 65 300, Micron Semiconductors Ltd., 92 mm diameter). In between detector housing and HV chamber, an intermediate chamber of 220 mm length is fixed to insert position calibration mask if needed.

The off-line testing of the detector has been performed using Cf fission fragment source. The isobutane gas pressure of 20 mbar maintained with constant flow configuration was enough to stop fission fragments in the active volume. The optimum bias

voltage for anode, cathode, grid electrode and entrance window were found to be 250, -190, 125 and -135 V respectively. The shaping time of amplifiers for anode, cathode and

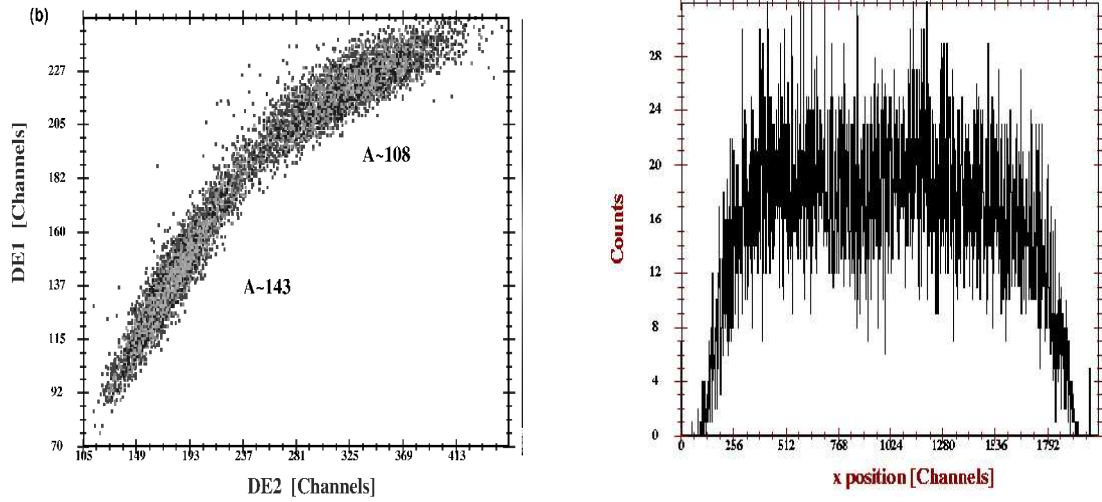

grid electrode were $1\mu\text{s}$, $2\mu\text{s}$ and $0.5\mu\text{s}$ respectively.

Fig. 1. (a) The two dimensional energy spectrum. The fission fragments are clearly seen to be separated on both the axes. The inset in the figure is the signal of the second anode. (b) x-position spectrum, appears semi-circular due to circular detector entrance window

The two fission fragments are seen separately in the first two anodes sections (inset of Fig.1a). The best way to see the separation of the fission fragments is through the two-dimensional spectra as shown in Fig. 1a which is plotted for $\Delta E1$ and $\Delta E2$. The position sensitivity could not be tested because of low activity of the source. However, the x-position spectrum (Fig. 1b) of the entire aperture gives the signature of the circular window.

4.5 LIBR BEAM LINE

4.5.1 Status of LIBR Beam Line For Beam-Foil Experiments

Nissar Ahmad¹, Ranjeet Karn and T. Nandi

¹Department of Physics, AMU, Aligarh

It was noticed that some x-ray lines observed in the beam-foil spectrum were originated from the nuclear transfer reaction of the projectile ion and carbon -foil target. Therefore, it was thought that corresponding γ lines for the transfer product can be looked for. With this idea, one feature for gamma spectroscopy was added this year to the earlier facility reported in this section of last year's annual report. A HPGe detector was put up at 0 degree in the end of the beam line. Last beam line flange made of alumin-

um was converted to a γ -cup. Its wall was thinned down to only 2mm and in front of it, a 0.25 mm graphite sheet was stuck. Any nuclear products produced in the reaction of projectile ions with carbon target would be stopped at the graphite sheet and γ emitted from the nuclear products can be recorded. There is an electron suppressed Faraday cup which can be inserted in between the target and graphite sheet. This enable us to measure the total charge collected in the Faraday cup, whenever required by interrupting the γ data collection. A photograph of the entire set up is shown in the Fig. 1.



Fig. 1 Present beam-foil set up in the LIBR beam line

4.5.2 Inclined plate electrostatic charge state analyzer

Nissar Ahmad¹, Rewa Ram and T. Nandi

¹Department of Physics AMU, Aligarh

Knowledge of post-foil charge state distribution is always useful in selecting the beam energy at a particular charge state of interest with its maximum yield. A conventional technique frequently used for studying this distribution in post-foil beam up to a few MeV/A is a parallel plate electrostatic analyzer (PPESA). One of the disadvantages with PPESA at high energy (5 MeV/A) is due to low spatial resolution with moderate bias potential. Resolution can be substantially improved by increasing the drift space. However, this increases the volume load due to longer drift space which may affect the resolution because of additional divergence of the beam. Another way of improving the resolution is either by applying higher plate voltage or by using longer electrodes. But application of higher voltage to the electrodes, after a certain limit [e.g., about 100 kV/cm at 10^{-7} Torr for stainless steel [1]], may pose a discharging risk between the electrodes. Moreover, the problem of ions hitting the plate at higher charge states, may restrict the

use of longer plates, thus limiting the use to a few charge states. Nevertheless longer plates are preferred as the deflection varies quadratically with plate length and linearly with the plate voltage.

An alternative is to use an Inclined and Straight Plate Electrostatic Analyzer (ISESA). Though the basic principle of deflection is the same but only one plate is held parallel and the other kept inclined at a certain angle relative to beam axis. Therefore ISESA is asymmetric about the beam axis and not solvable. It is essential to apply the voltage to the plates in such a manner that the deflection must take place towards the inclined plate. Small gap between the plates at the entry causes large deflection due to large field. As the ions travel forward, the gap increases lowering the field which in turn allows the ions to escape the plate without hitting. A reflection symmetry of ISESA makes it symmetric and hence one solve the trajectories numerically.

Comparison of the results with that of equivalent parallel plate geometry (EISEA), i.e., $\text{gap} = 1/2$ (entry+exit gap) have been shown in the Fig 2. Parameters were fixed on the simulation.

On the basis of simulated results an ISESA have been fabricated at NSC (Fig. 3) and will be commissioned in the atomic physics beam line in beam hall II.

REFERENCE

- [1] R.V. Latham, High Voltage Vacuum Insulation: The Physical Basis, p. 39, Academic Press (1981)

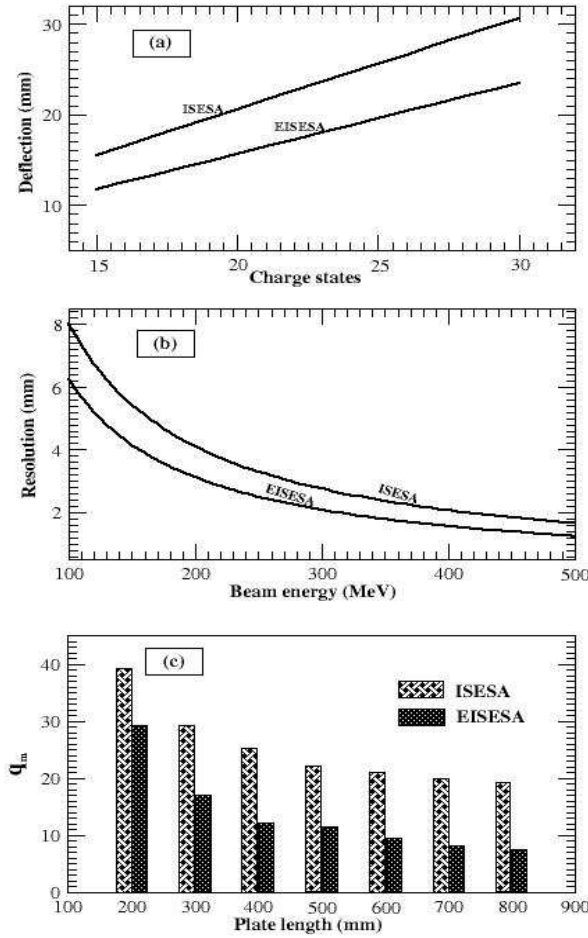
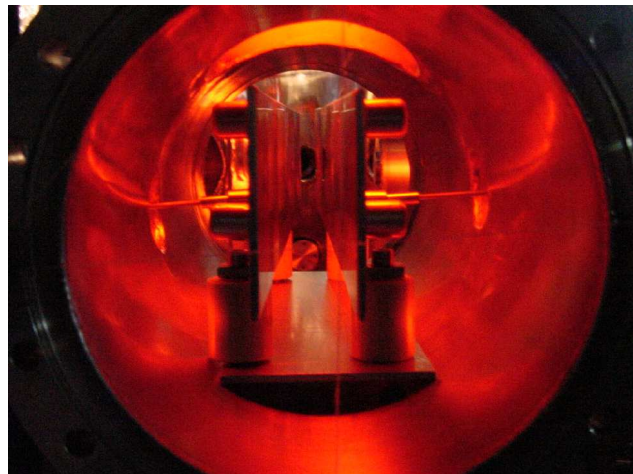

Fig. 2 Comparison of ISESA with other geometries (a) Deflection of the ions plotted against charge states for Applied voltage=20kV, inclination angle = 3 beam energy = 100 MeV and plate length=400mm (b) Plot featuring the variation in mean resolution Vs beam energy.



(c) Bar charge featuring maximum charge state q_m along Y-axis that come out without hitting the plate

Fig. 3. Inclined plate electrostatic analyser

4.6 RADIATION BIOLOGY BEAM LINE

4.6.1 Status of the Radiation Biology Beam line

A. Sarma, P. Barua, A. Kothari, R. Joshi and S. Chopra

The specially designed beam line can deliver beams of proton, ^7Li , ^{11}B , ^{12}C , ^{14}N and ^{16}O . The flux can be controlled from 10^2 particles/sec/cm² to 10^6 particles/sec/cm². The radiation field is having 30 mm diameter with better than 97% uniformity. The flux control is done by adjusting a double slit through CAMAC from control room. A preset controller for faraday cup ensures the exposure repetition as per user requirement. The beam line was relaid after the experimental set up for the Indian National Gamma Array experiments was shifted. Alignment has been done again and beam was delivered for the users experiment since January 2004.

4.6.2 Status of the Molecular Radiation Biology Laboratory

A. Sarma

The laboratory is designed to extend user support to the best possible way during experiments. The experiments that are undertaken recently require suitable in-house facilities for relevant protocols. Apart from the normal equipment like microbalance, autoclave, biosafety cabinet, oven, refrigerated centrifuge, PCR machine, Gel Doc, AFIGE system and Semi dry transblotter, etc., we have installed a -80°C Ultra Freezer [Heto] and a -20°C Deep Freezer [Vest Frost]. Apart from these, a fluorescent microscope [Carl Zeiss] has been installed to facilitate the experiments based on FISH and immunofluorescent assays.